

# TCX50H Tire Changer Family

## Operations Manual



**HUNTER**  
Engineering Company



# Hunter Engineering Company

*Dear Purchaser*

*Thank you for purchasing your Hunter Tire Changer.*

*Your Tire Changer has been designed to provide years of safe and dependable service, as long as it is used and maintained in accordance with the instructions provided in this manual.*

*All persons who will use and/or maintain this Tire Changer must read, understand and follow all warnings and instructions provided in this manual, and be properly trained.*

*This Owner's Manual should be considered an internal part of your Tire Changer and should remain with the Tire Changer. However, nothing in this manual, and none of the devices installed on the Tire Changer, substitute for proper training, careful operation, good judgment and safe work practices.*

*Always be sure that your Tire Changer is in optimum working order. If you suspect that anything is not working properly, or that a dangerous situation may exist, immediately shut down the Tire Changer and remedy any condition before you proceed.*

*If you have any questions concerning the proper use or maintenance of your Tire Changer, please call your authorized Hunter Engineering Company representative..*

*You can also contact Hunter Engineering Company at Tel: 800-448-6848 or 314-731-3020, Fax. 314-731-1776 or use*

*Sincerely,*

*Hunter Engineering Company*

## OWNER INFORMATION

Owner Name \_\_\_\_\_  
Owner Address \_\_\_\_\_  
Model Number \_\_\_\_\_  
Serial Number \_\_\_\_\_  
Date Purchased \_\_\_\_\_  
Date Installed \_\_\_\_\_  
Service and Parts Representative \_\_\_\_\_  
Phone Number \_\_\_\_\_  
Sales Representative \_\_\_\_\_  
Phone Number \_\_\_\_\_

### Training Checklist

#### **Safety Precautions**

#### **Trained**

#### **Declined**

Warning and Caution Labels

Pinch Points and Other Potential Hazards

Safe Operating Procedures

#### **Maintenance and Performance Checks**

Mounting Head Inspection

Adjustment and Filling of Oilers

#### **Bead Breaking**

Standard Wheels

Low Profile Wheels

#### **Clamping**

Steel Jaw Internal/External Clamping

#### **Demounting**

Standard Wheels with Bead Lever and Plastic Sleeve Protector

Full Seating of Mount/Demount Head to Prevent Head Failure

Bead Lubrication During Removal of Low Profile Tires

Reverse Drop Center Wheels

**Mounting**

**Trained**

**Declined**

Standard Wheels

Mounting of Stiff, Low Profile Tires

Reverse Drop Center Wheels

Proper Bead Lubrication for Mounting Protection

**Inflation**

**Trained**

**Declined**

Safety Precautions

Lubrication and Removal of Valve Core

Bead Sealing and Seating

**Individuals and Dates Trained**

---

---

---

---

---

---

---

---

---

---

---

---

# Contents

<b>1. Getting Started</b> .....	<b>8</b>
<b>1.1 Introduction</b> .....	<b>8</b>
1.1.a – PURPOSE OF THE MANUAL.....	8
<b>1.2 For Your Safety</b> .....	<b>9</b>
Hazard Definitions .....	9
<b>1.3 General Warnings and Instructions</b> .....	<b>9</b>
Electrical Indications .....	13
Specific Precautions/Power Source.....	14
Equipment installation and service.....	14
Equipment specification .....	14
Explanations of symbols .....	14
1.3.b. Air Pressures.....	15
<b>1.4 Special Rim/Tire Considerations</b> .....	<b>15</b>
<b>1.5 Intended Use of The Machine</b> .....	<b>15</b>
<b>1.6 Employee Training</b> .....	<b>16</b>
<b>1.7 Pre-Use Checks</b> .....	<b>16</b>
<b>1.8 During Use</b> .....	<b>17</b>
<b>1.9 Control Pedal Configurations</b> .....	<b>17</b>
<b>1.10 Wheel Rotation Pedal</b> .....	<b>17</b>
<b>1.11 Tire Bead Breaker Shovel control</b> .....	<b>18</b>
<b>1.12 Wheel Clamping Pedal</b> .....	<b>18</b>
<b>1.13 Air Inflation Pedal</b> .....	<b>19</b>
<b>1.14 Moving Parts</b> .....	<b>19</b>
<b>1.15 Inflator and Pressure Limiter</b> .....	<b>19</b>
<b>1.16 Mount / Demount Head</b> .....	<b>20</b>
<b>1.17 Equipment Components</b> .....	<b>21</b>
<b>2. Basic Procedures</b> .....	<b>22</b>
<b>2.1 Bead Breaking</b> .....	<b>22</b>
<b>2.2 Placing Wheel on Tire Changer</b> .....	<b>23</b>
Clamping the Wheel from Inside of Rim - Steel Rims .....	23
Clamping the Wheel from Outside of Rim - Alloy Rims .....	23
<b>2.3 Demounting Standard Tire from Rim</b> .....	<b>25</b>
Standard Mount / Demount Head .....	25
PLASTIC PROTECTORS BEAD LEVER .....	25
<b>2.4 Tire Inflation</b> .....	<b>27</b>
Special procedure .....	28
<b>2.5 Removal of Wheel from Tire Changer</b> .....	<b>30</b>
<b>2.6 Optional Clamping Jaw Extensions</b> .....	<b>30</b>
<b>3. Advanced Procedures</b> .....	<b>31</b>
<b>3.1 Advanced Bead Breaking Procedures</b> .....	<b>31</b>
Bead Breaking “AH” Wheels (e.g. BMW M3, M5, Some Porsches, Range Rover, Lancia, etc.) .....	31
Bead Breaking “AH” Wheels as follows: .....	31
<b>3.2 Advanced Demounting Procedures</b> .....	<b>32</b>
Demounting Tire from Rim Using the Bead Lever Tool without the Plastic Sleeve Protector .....	32
Demounting Upper Bead .....	32
Demounting Lower Bead .....	32

<b>3.3 Advanced Mounting Procedures</b> .....	<b>33</b>
<b>3.4 Mount/Demount Head Assembly</b> .....	<b>33</b>
Checking Mount/Demount Head Calibration For Steel Heads .....	33
Set Position of Steel Mount/Demount Head on Hex Shaft .....	33
For Tilting Plastic Heads .....	35
Set Position of Plastic Mount/Demount Head on Hex Shaft .....	35
Adjust the Offset of Lock Mechanism – Steel and Plastic Heads .....	36
<b>4. TCX51H Operational Supplement</b> .....	<b>37</b>
<b>BP Arm Operation</b> .....	<b>37</b>
<b>4.1 General Information</b> .....	<b>37</b>
<b>4.2 Part Identification</b> .....	<b>37</b>
<b>4.3 Operation</b> .....	<b>38</b>
Clamping the Wheel .....	38
Demounting .....	39
Using the Bead Press Head Hook to Lift the Tire .....	40
Mounting .....	40
<b>5. TCX53H Operational Supplement</b> .....	<b>42</b>
<b>Bead Press System Operation</b> .....	<b>42</b>
<b>5.1 General Information</b> .....	<b>42</b>
<b>5.2 Part Identification</b> .....	<b>42</b>
<b>5.3 Operation</b> .....	<b>43</b>
Clamping the Wheel.....	43
Lubrication of Outer Bead .....	43
Demounting the Outer Bead .....	44
Breaking the Inner Bead .....	45
Demounting the Inner Bead .....	46
Operations and Inspections Prior to Mounting .....	46
Mounting the Inner Bead .....	46
Mounting .....	46
Special Procedure for Run Flat Wheels / Low Profile .....	47
Bead Breaking .....	47
Second Roller Attachment .....	47
Mounting the Outer Bead .....	48
Sensor Inspection/Replacement .....	49
<b>6. Maintenance</b> .....	<b>50</b>
<b>6.1 Maintenance Schedule</b> .....	<b>50</b>
<b>6.2 Maintenance and Replacement Parts</b> .....	<b>52</b>
<b>7. Glossary</b> .....	<b>53</b>
<b>7.1 Rim Diagram</b> .....	<b>53</b>
<b>7.2 Illustrations of Various Rim Designs</b> .....	<b>54</b>

# 1. Getting Started

---

## 1.1 Introduction

### 1.1.a – PURPOSE OF THE MANUAL

The purpose of this manual is to provide the instructions necessary for optimum operation, use and maintenance of your machine. If you sell this machine, please deliver this manual to the new owner. In addition, so we can contact our customers with any necessary safety information, please ask the new owner to complete and return to Hunter the change of ownership form attached to the last page of this manual. Alternately, the new owner can send an email to [newuser@hunter.com](mailto:newuser@hunter.com).

This manual presumes that the technician has a thorough understanding of rim and tire identification and service. He/she must also have a thorough knowledge of the operation and safety features of all associated tools (such as the rack, lift, or floor jack) being utilized, and have the proper hand and power tools necessary to work in a safe manner.

The first section provides the basic information to safely operate the TCX50H tire changer family. The following sections contain detailed information about equipment, procedures, and maintenance. “Italics” are used to refer to specific parts of this manual that provide additional information or explanation. For example, Refer to “*Equipment Components*” page 21. These references should be read for additional information to the instructions being presented.

The owner of the tire changer is solely responsible for enforcing safety procedures and arranging technical training. The tire changer is to be operated only by a qualified and trained technician. Maintaining records of personnel trained is solely the responsibility of the owner or management.

The TCX50H tire changer family is intended for mounting, demounting, and inflating most tires with an approximate dimension of 50 inches in diameter and 15 inches in width.

Copies of this manual and of the documents accompanying the machine may be obtained from Hunter Engineering Company by specifying the type of machine and its serial number.

**NOTICE:** Design details are subject to change. Some illustrations may vary slightly in appearance from the machine you have.”

An advanced operation section has been provided in “*Advanced Procedures,*” page 31.



---

## 1.2 For Your Safety

### Hazard Definitions

These symbols identify situations that could be detrimental to your safety and/or cause equipment damage.

 <b>DANGER</b>
 <b>DANGER:</b> Indicates an imminently hazardous situation which, if not avoided, will result in death or serious injury.

 <b>WARNING</b>
 <b>WARNING:</b> Indicates a potentially hazardous situation which, if not avoided, could result in death or serious injury.

 <b>CAUTION</b>
 <b>CAUTION:</b> Indicates a potentially hazardous situation which, if not avoided, may result in minor or moderate injury.

<b>NOTICE</b>
<b>NOTICE:</b> Used without the safety alert symbol indicates potentially hazardous situation, which, if not avoided, may result in property damage.

---

## 1.3 General Warnings and Instructions

 <b>WARNING</b>
<b>Avoid Personal Injury.</b> Carefully read, understand and follow the warnings and instructions given in this manual. This manual is an essential part of the product. Keep it with the machine in a safe place for future reference.

1. If the use and maintenance procedures provided in this manual are not properly performed, or the other instructions in this manual are not followed, an accident could occur. Throughout this manual reference is made that “an accident” could occur. Any accident could cause you or a bystander to sustain severe personal injury or death, or result in property damage.



## WARNING

**Avoid Personal Injury. Carefully read, understand and follow the warnings and instructions given in this manual. This manual is an essential part of the product. Keep it with the machine in a safe place for future reference.**

2. Overinflated tires can explode, producing hazardous flying debris that may result in an accident.
3. Tires and Rims that are not the same diameter are “mismatched.” Never attempt to mount or inflate any tire and rim that are mismatched. For example, never mount a 16.5” tire on a 16” rim and vice versa. This is very dangerous. A mismatched tire and rim could explode and result in an accident.
4. Never exceed the bead setting pressure (gauge on hose) provided by the tire manufacturer, as stated on the sidewall of the tire.
5. Never place your head or any part of your body over a tire during the inflation process or when attempting to seat beads. This machine is not intended to be a restraining device for exploding tires, tubes or rims.
6. Never use an inflation source other than the regulated pressure system on the tire changer.
7. Use a safety cage in accordance with tire manufactures recommendations if inflation pressures beyond the tire changer equipped regulated air is required.



## DANGER

**An exploding tire and rim may be propelled upward and outward with enough force to cause serious injury or death.**

**Never mount any tire unless the tire size (molded into the sidewall) matches the rim size (stamped into the rim) exactly or if the rim or tire are defective or damaged.**

**Never exceed tire pressure recommended by tire manufacturer.**

**This tire changer is not a safety device and will not restrain exploding tires and rims. Keep area clear of bystanders.**

8. **Crushing Hazard. Moving Parts Present.** Contact with moving parts could result in an accident.



- Only one operator may work with the machine at a time.
- Keep all bystanders clear of tire changer.
- Keep hands and fingers clear of rim edge during demounting and mounting process.
- Keep hands and fingers clear of mount/demount head during operation.
- Keep hands and other body parts away from moving parts.
- Do not use tools other than those supplied with tire changer.
- Use proper tire lubricate to prevent tire binding.



## WARNING

**Avoid Personal Injury. Carefully read, understand and follow the warnings and instructions given in this manual. This manual is an essential part of the product. Keep it with the machine in a safe place for future reference.**

### 9. Electric Shock Hazard.



- Never hose down or power wash electric tire changers.
- Do not operate machine with a damaged power cord
- If an extension cord is necessary, a cord with a current rating equal to or greater than that of the machine must be used. Cords rated for less current than the machine can overheat, resulting in a fire.
- Care should be taken to arrange the cord so that it will not be tripped over or pulled.

10. Risk of Eye Injury. Flying debris, dirt and fluids may be discharged during bead seating and inflation process. Remove any debris from the tire tread, wheel surfaces. Wear OSHA approved safety glasses during mount and demount procedures.
11. Always inspect the machine carefully before using it. Missing, broken, or worn equipment (including warning stickers) must be repaired or replaced prior to operation.
12. Never leave nuts, bolts, tools or other equipment on the machine. They may become trapped between moving parts and cause a malfunction.
13. NEVER install or inflate tires that are cut, damaged, rotten or worn. NEVER install a tire on a cracked, bent, rusted, worm, deformed or damaged rim.
14. If a tire becomes damaged during the mounting process, do not attempt to finish mounting. Remove from service area and properly mark the tire as damaged.
15. To inflate tires, use short bursts while carefully monitoring the pressure, tire, rim and bead. NEVER exceed tire manufacturer's pressure limits.
16. This equipment has internal arcing or sparking parts which should not be exposed to flammable vapors (gasoline, paint thinners, solvents, etc.). This machine should not be located in a recessed area or below floor level.
17. Never operate the machine if you are under the effects of alcohol, medications and/or drugs. If you are taking prescription or over the counter medication, you must consult a medical professional regarding any side effects of the medication that could hinder your ability to operate the machine safely.
18. Always use OSHA approved and mandated Personal Protective Equipment (PPE) during use of the machine. See your supervisor for more instructions.
19. Remove jewelry, watches, loose clothing, ties and restrain long hair before using machine.
20. Wear non-slip safety footwear when operating the tire changer.
21. Wear proper back support and employ proper lifting technique when placing, moving, lifting or removing wheels from the tire changer.
22. This machine may only be used, maintained or repaired by properly trained employees of your company. Repairs should only be performed by qualified personnel. Your Hunter service representative is the most qualified person. The employer is responsible for determining if an employee is qualified to safely make any repairs to the machine should repair be attempted by users.
23. The user should understand all warnings decals affixed to this equipment before operating.
24. Do not lock the rim on the turntable during inflation.

**DECAL PLACEMENT**

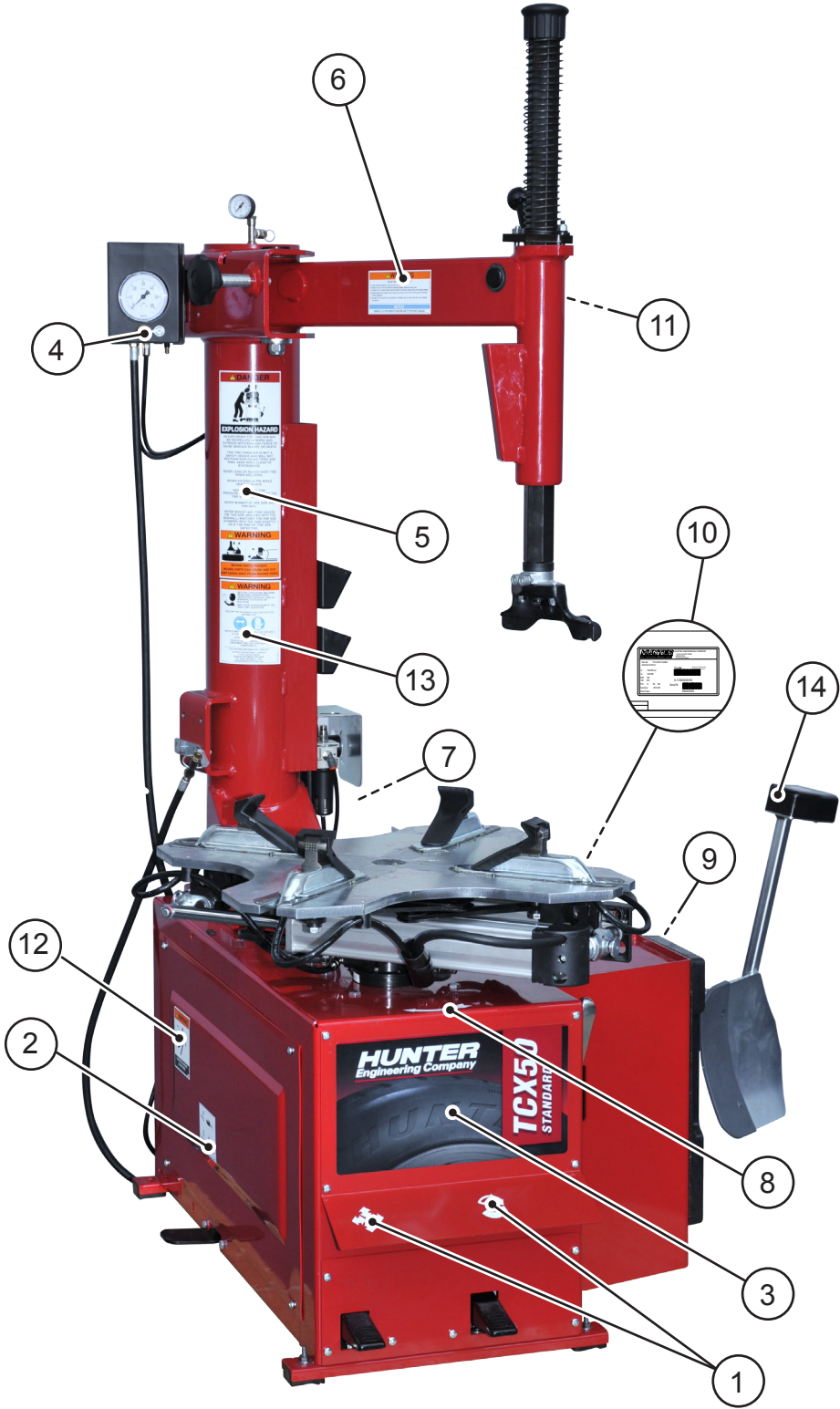

No.	Part Number	Description
1	RP11-4-123655	DECAL-PEDAL OPERATION
2	RP11-4-402030	DECAL-INFLATRON PEDAL OPERATION
3	128-1484-2	DECAL-HUNTER LOGO TCX50
	128-1485-2	DECAL-HUNTER LOGO TCX51
	128-1486-2	DECAL-HUNTER LOGO TCX53
4	RP11-4-402021	DECAL-MANUAL TIRE BLEED VALVE
5	RP11-4-115244	DECAL-DANGER OPERATION
6	RP11-4-115243	DECAL-WARNING OPERATION
7	RP11-4-402027	DECAL-MAXIMUM INLET PRESSURE
8	RP11-3020842	DECAL-TABLE ROTATION
9	RP11-4-402023	DECAL-RIM, TABLE, BEAD, BREAKER, BEAD AIR PRESSURE
10	RP11-4-402034	DECAL-MODEL SERIAL NUMBER
11	RP11-4-402031	DECAL-VERTICAL COLUMN LOCK LEVER OPERATION
12	RP11-4-115246	DECAL-ELECTRICAL HAZARD
13	RP11-4-115245	DECAL-WARNING INDICATION
14	RP11-3013640	DECAL-ARROWS LEFT-RIGHT

### Electrical Indications

The TCX50H family is manufactured to operate at a specific voltage and amperage rating.

Make sure that the appropriate electrical supply circuit is of the same voltage and amperage ratings as marked on the TCX50H.

 <b>WARNING</b>
<b>FIRE HAZARD. DO NOT ALTER THE ELECTRICAL PLUG.</b>

<b>NOTICE</b>
<b>Plugging the electrical plug into an unsuitable supply circuit will damage the equipment.</b>

	 <b>DANGER</b>
	<ul style="list-style-type: none"> <li>• <b>HAZARDOUS VOLTAGE</b></li> <li>• <b>Turn off and lock out system power before servicing.</b></li> <li>• <b>Contact may cause electric shock or death.</b></li> </ul>

Make sure that the electrical supply circuit and the appropriate receptacle is installed with proper grounding.

To prevent the possibility of electrical shock injury or damage to the equipment when servicing the TCX50H, power must be disconnected by removing the power cord from the electrical power outlet.

### Specific Precautions/Power Source

The TCX50H is equipped with motoinverter, (220VAC/ 1 PH / 50-60Hz), and standard plug 220V L6-20P plug.

This machine must be connected to a 20 amp branch circuit. Please refer all power source issues to a certified electrician. Refer to "Installation Instructions for TCX50H Tire Changer," Cod. 4-122308.

 <b>WARNING</b>
<b>A protective ground connection, through the grounding conductor in the power cord, is essential for safe operation. Use only a power cord that is in good condition.</b>

### Equipment installation and service

A factory-authorized representative should perform installation.

This equipment contains no user serviceable parts. All repairs must be referred to a qualified Hunter Service Representative

### Equipment specification

<b>Electrical</b>	
Voltage:	220 VAC, 1 phase, 50-60 Hz, includes NEMA L6-20P
Circuit size:	20 amps
<b>Air</b>	
Air Pressure Requirements:	115-175 PSI (7.9-12.0 bar)
Approximate Air Consumption:	at 8 bar = 6 Lt/s • 0.2118 Ft <sup>3</sup> /s • 12,70 CFM (ft <sup>3</sup> /min)
	at 10 bar = 7,76 Lt/s • 0.2471 Ft <sup>3</sup> /s • 14,82 CFM (ft <sup>3</sup> /min)
<b>Mechanical</b>	
Clamping System Rotating Speed:	CW – 7 rpm and 17 rpm CCW – 7 rpm
Max. Tire Diameter:	50 in.
Max Bead Roller Opening Width:	15 in.
Diameter Range:	10" – 26" (30" with optional adaptors)

### Explanations of symbols

These symbols may appear on the equipment.

 Alternating current.

 Earth ground terminal.

 Protective conductor terminal.



Risk of electrical shock.

### 1.3.b. Air Pressures

The machine is equipped with an internal pressure limiting valve to minimize the risk of over inflating the tire.

	<p style="text-align: center;"> <b>DANGER</b></p> <ul style="list-style-type: none"><li>• <b>EXPLOSION HAZARD</b></li><li>• <b>Never exceed tire pressure recommended by tire manufacturer. Never mismatch tire size and rim size.</b></li><li>• <b>Avoid personal injury or death.</b></li></ul>
---	--

1. Never exceed these pressure limitations:
  - Supply line pressure (from compressor) is 220 psi.
  - Operating pressure (gauge on regulator) is 145 psi.Bead setting pressure (gauge on hose) is the tire manufacturer's maximum pressure as stated on the sidewall of the tire.
2. Activate air inflation jets only when sealing bead.
3. Bleed air pressure system before disconnecting supply line or other pneumatic components. Air is stored in a reservoir for operation of inflation jets.
4. Only activate the air inflation jets if the rim securing device is locked in place and the tire is properly clamped (when possible).
5. Only use supplied inflation hose with a properly functioning regulator.
6. Never inflate using "shop air" on the tire changer.
7. Use a safety cage in accordance with tire manufactures recommendations if inflation pressures beyond the tire changer equipped regulated air is required.

---

## 1.4 Special Rim/Tire Considerations

### **NOTICE**

**Wheels equipped with low tire pressure sensors or special tire and rim designs may require certain procedures. Consult wheels and tire manufacturer's service manuals.**

---

## 1.5 Intended Use of The Machine

This machine must be used only to remove and replace an automotive tire on an automotive rim, using the tools with which it is equipped. Any other use is improper and can result in an accident.

---

## 1.6 Employee Training

1. The employer is obligated to provide a program to train all employees who service rim wheels in the hazards involved in servicing those rim wheels and the safety procedures to be followed. Service or servicing means the mounting and demounting of rim wheels, and related activities such as inflating, deflating, installing, removing and handling.
  - The employer shall insure that no employee services any rim wheel unless the employee has been trained and instructed in correct procedures of servicing the type of wheel being serviced, and in the safe operating procedures.
  - Information to be used in the training program shall include, at a minimum, the applicable information contained in this manual.
  
2. The employer shall ensure that each employee demonstrates and maintains the ability to service rim wheels safely, including performance of the following tasks:
  - Demounting of tires (including deflation).
  - Inspection and identification of the rim wheel components.
  - Mounting of tires.
  - Use of any restraining device, cage, barrier, or other installation.
  - Handling of rim wheels.
  - Inflation of the tire.
  - Understanding the necessity of standing back from tire changer during inflation of the tire and during inspection of the rim wheel following inflation, never lean over.
  - Installation and removal of rim wheels.
  
3. The employer shall evaluate each employee's ability to perform these tasks and to service rim wheels safely and shall provide additional training as necessary to assure that each employee maintains his or her proficiency.

---

## 1.7 Pre-Use Checks

Before beginning work, carefully check that all components of the machine, especially rubber or plastic parts, are in place, in good condition and working properly. If the inspection reveals any damage or excessive wear, no matter how slight, immediately replace or repair the component.

Walk around the machine to ensure that all components are in good condition and operational and that there are no foreign objects or debris (rags, tools, etc...) in or about the machine which could affect its operation.

These checks must be carried out:

- Before starting the machine.
- At regular time intervals.
- After any modification or repair.

The machine may only be started after this pre-use check is successfully completed.

Do not use the machine if it is placed out of service for a tune up, maintenance, lubrication, etc.



---

## 1.8 During Use

In the event you hear any strange noise or feel unusual vibrations, if a component system is not operating properly or if there is anything unusual at all, stop using the machine immediately.

- Identify the cause and take any necessary remedial action.
- Contact your supervisor if necessary.

Never allow any bystander to be within 20 feet of the machine during operation.

To stop the machine in an emergency:

- disconnect the power supply plug;
- cut off the compressed air supply network by disconnecting the shut-off valve (snap coupling).

---

## 1.9 Control Pedal Configurations

 <b>WARNING</b>
<b>Avoid unintended machine movement and personal injury. Pay close attention to the configuration of your machine.</b>

Throughout this manual, control pedals are referred to by the associated symbol.

### CLAMP

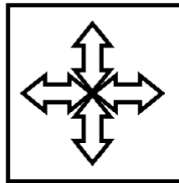

### ROTATION



The PowerOut system provides bead breaking controls on the handle for convenience, particularly with larger diameter assemblies.

---

## 1.10 Wheel Rotation Pedal



Step down on the rotation pedal to rotate the wheel clockwise.

Lift up on the pedal to rotate the wheel counterclockwise.

## 1.11 Tire Bead Breaker Shovel control

 <b>WARNING</b>	
Keep arms and legs from between the bead breaker arm and the side of the housing.	

 <b>NORMAL RIMS UP TO 10"</b>	 <b>WIDE RIMS OVER 10"</b>	 <b>CRUSH HAZARD</b>  <b>KEEP HANDS CLEAR OF ROTATING TABLE</b>	 <b>CRUSH HAZARD</b>  <b>KEEP ARMS AND LEGS CLEAR OF BEAD BREAKER</b>	 <b>EXPLOSION HAZARD</b>  <b>DO NOT BREAK BEAD WITH AIR PRESSURE IN TIRE.</b>
---	--	--	---	--

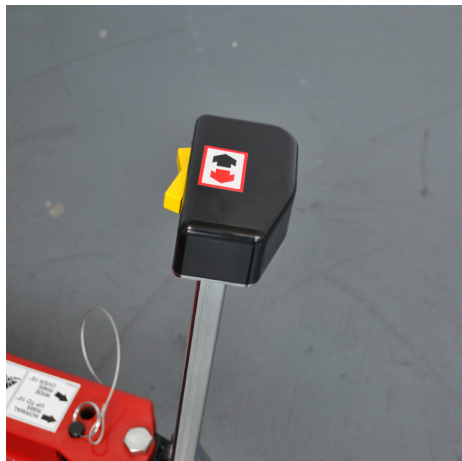

Press the "In" button to close bead breaker arm and loosen bead (red arrow).  
Press the "Out" button to allow the bead breaker arm to open (black arrow).

## 1.12 Wheel Clamping Pedal

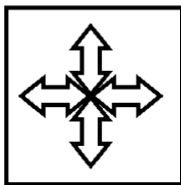

The wheel clamping pedal has three positions (modes of operation): up (expand), neutral (stop), and down (retract).

With the clamps in the fully retracted position or clamped against the outside of a rim, step down fully on the pedal to expand the wheel clamps (clamps move outward). The clamps continue to expand until contacting the rim or until fully expanded.

### Internal Clamping:

Press the pedal all the way down to close the 4 sliding clamps completely.

Put the wheel on the table top and depress pedal all the way down, (the pedal will move in the upper position). The 4 sliding clamps will open and clamp the wheel.

### External clamping:

Press the pedal to the middle position to position the 4 sliding clamps so that the reference on the table top is more or less in line with the tire diameter stamped on the sliding clamp.

Place the wheel on the table top and push down on the wheel while depressing the pedal all the way to clamp the wheel.

## 1.13 Air Inflation Pedal

On the left side of the base, the air inflation pedal operates the two-stage air inflation system. Refer to illustrations on page 27. The pedal controls the air going to the inflation hose and the air inflation jets.

	<p style="text-align: center;"> <b>DANGER</b></p> <ul style="list-style-type: none"><li>• <b>EXPLOSION HAZARD</b></li><li>• Never exceed tire pressure recommended by tire manufacturer. Never mismatch tire size and rim size.</li><li>• Avoid personal injury or death.</li></ul>
---	--

 <b>WARNING</b>	
Keep hands clear of wheel during sealing and seating of beads.	

 <b>WARNING</b>	
<p><b>Risk of Tire Failure When Driving.</b> Excessive air pressure can damage the internal structure of a tire, without this damage being visible to you, resulting in an automobile accident, personal injury or death.</p>	

## 1.14 Moving Parts

	<p style="text-align: center;"> <b>WARNING</b></p> <ul style="list-style-type: none"><li>• <b>MOVING PARTS PRESENT. MOVING PARTS CAN CUT AND CRUSH.</b></li><li>• Keep hands away from moving parts.</li><li>• Crush may cause injury.</li></ul>
---	---

## 1.15 Inflator and Pressure Limiter

As a safety device, the pressure limiter prevents the operator from using excessive air pressure.

Bead seating pressure should never exceed the tire manufacturer's maximum bead seating pressure as stated on the sidewall of the tire.

If tires being mounted require more than the tire manufacturer's maximum bead seating pressure, the wheel should be removed from the tire changer, placed in an inflation cage, and inflated per manufacturer's instructions.

## 1.16 Mount / Demount Head

	<p style="text-align: center;"> <b>WARNING</b></p> <ul style="list-style-type: none"><li>• <b>MOVING PARTS PRESENT.</b> <b>MOVING PARTS CAN CUT AND CRUSH.</b></li><li>• Keep hands away from moving parts.</li><li>• Crush may cause injury.</li></ul>
---	--

The mount/demount head is suspended from the column above the turntable.

The head has a mounting and demounting lip that is designed to install or remove the bead of tire as the wheel is rotated clockwise.

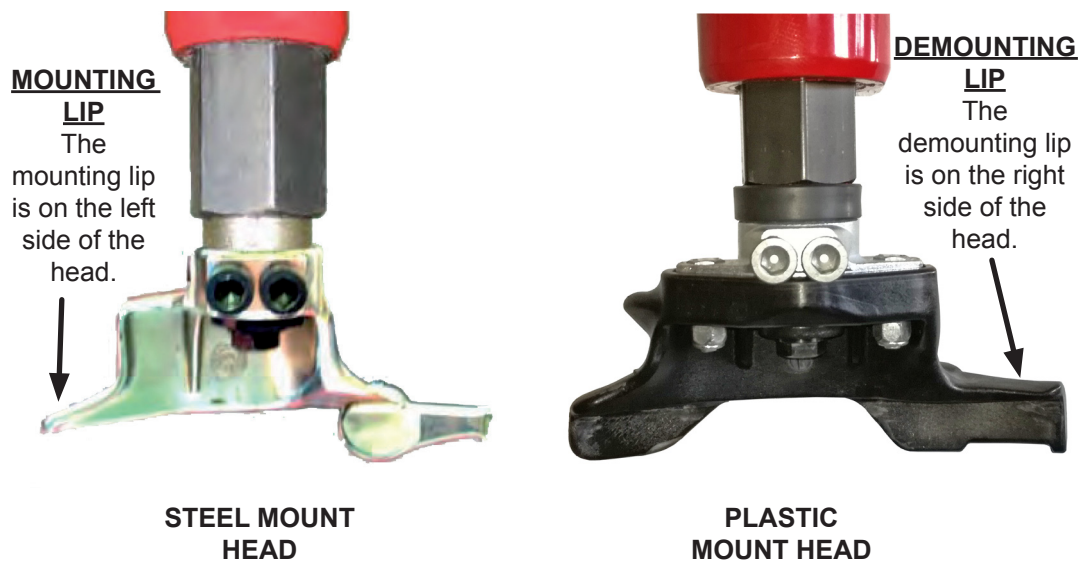

## 1.17 Equipment Components

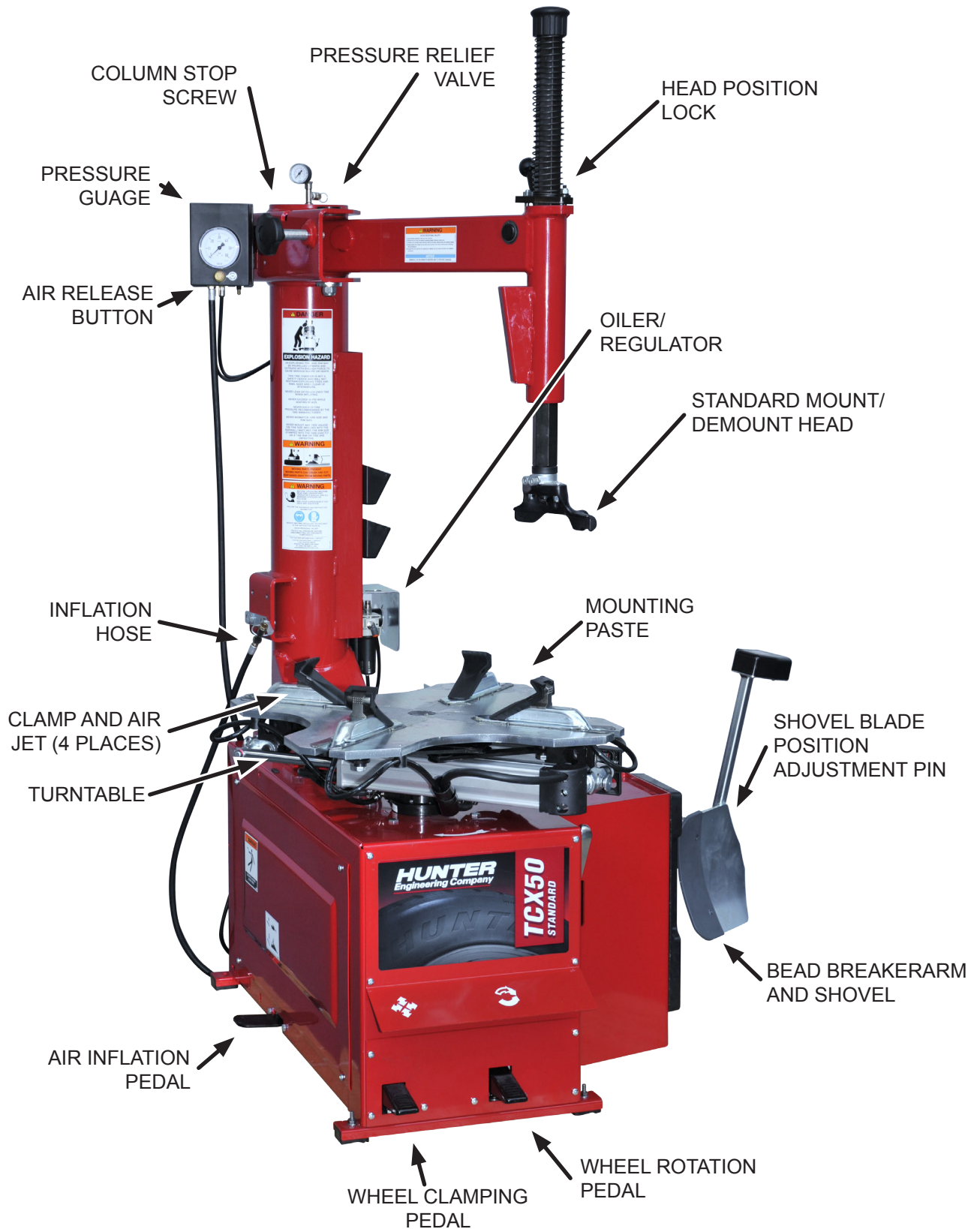

## 2. Basic Procedures

### 2.1 Bead Breaking



### WARNING

All air pressure inside the tire must be removed before proceeding. Never attempt to break the bead until all air is removed from the tire. Failure to remove all air from tire may result in injury to operator, or damage to equipment, tire, or wheel.

Remove valve stem core to deflate tire completely. Remove all weights from the rim to protect the rim and extend life of the mount/demount head.

The shovel blade has two-position adjustment. The second position is for wheels 10" wide and larger, but also may be used to break the beads of extreme low profile tires.

Press the "Out" button to allow the bead breaker arm to open and position the wheel against the side of the tire changer, between the bead-breaker arm and the housing.

Press the "In" button to bring the bead breaker arm toward the tire and position the shovel blade on the sidewall of the tire. Locate the blade close, but not contacting, the edge of the rim.

Press the "In" button again to close bead breaker arm and loosen bead.

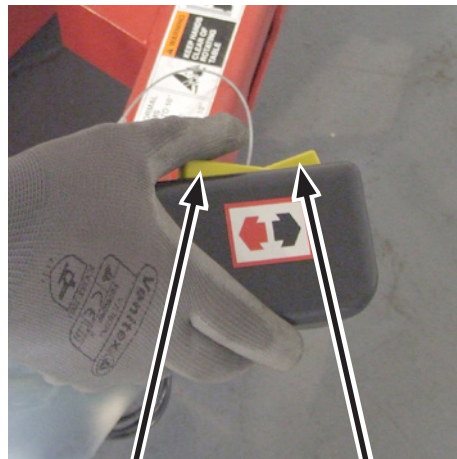

"In" button

"Out" button



Release the “In” button to disengage the bead-breaker arm and press the “Out” button to allow the bead breaker arm to open. If the bead has not completely loosened, rotate the wheel and repeat the bead breaking procedure at a different area on the tire.

Turn the wheel and break the opposite bead using the same procedure.

## 2.2 Placing Wheel on Tire Changer

Identify and recognize special wheel combinations such as Reverse Drop Center (needs inverted on changer), AH, “Run-Flat” Extended Mobility Tires, and standard tires with pressure sensors. If you are not fully familiar with these special wheel considerations, DO NOT USE the tire changer. See your supervisor.

### Clamping the Wheel from Inside of Rim - Steel Rims

Identify the inner locations on the rim where the clamps will come in contact.

Position the clamps in the fully retracted position (clamps completely in).

Place the wheel centered onto the turntable.



Step down  on the clamping pedal to expand the clamps to the rim.

## NOTICE

**Avoid clamping inside rim of alloy wheels. Steel jaws may damage the finish of inside rim surface during use.**

**Verify that the wheel has been properly clamped and centered.**

### Clamping the Wheel from Outside of Rim - Alloy Rims

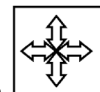

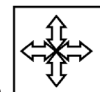
Place the clamping pedal in the stopped position by partially stepping down  on the pedal with the clamps expanding or in the fully expanded position.

From this stopped position, use additional partial steps on the clamping pedal to incrementally retract the clamps. Set the clamps to the mark on the turntable that corresponds to the size of rim to be clamped (12” - 14” - 16”).

Place the wheel onto the turntable.

Continue to incrementally retract the clamps until all four clamps contact the rim.



Step down  once only on the clamping pedal to fully retract the clamps to the rim.

## NOTICE

***Always verify that all four clamps are on the rim before applying pressure to prevent possible damage to the rim.***

Plastic jaw covers may be used to help maintain rim protection when clamping externally.

Plastic covers also be used to prevent wheel slip.

Plastic jaw covers may be replaced periodically when worn by ordering kit RP11-8-11100358 which contains 2 sets of plastic covers.

This tire changer is equipped with an adjustable turntable ; there are two knobs that allow extended clamping capacity up to 26 " (up to 26" clamping externally / up to 28" clamping internally).

- with the knobs facing outwards, we have a clamping capacity that goes from 10" to 22" (clamping externally).



- with the knobs facing inwards we have a clamping capacity that goes from 14" to 26" (clamping externally).



To get this feature, pull the knob and rotate to move through an angle of 180 ° (note: the pin knob must fit into the locking hole).

It is always necessary that the two knobs are in the same position with respect to center of the turntable: both facing outwards (10"-22") or both facing inward (14"-26").

A mixed position, with a knob facing outwards and the other facing inwards, is not recommended.





## 2.3 Demounting Standard Tire from Rim

### Standard Mount / Demount Head

#### **NOTICE**

Clean the mount/demount head to remove dirt and debris before demounting the tire from the rim.

Press the wheel rotation pedal until the valve location is in the one o'clock position.

Position the mount/demount head against the outer edge of the upper rim lip.

Slide the mount/demount head in or out along the upper rail and lower the head into position. Pull the head position lock handle to lock head into position.

A plastic protector sleeve may be installed on the bead lever tool to aid in rim protection.

### PLASTIC PROTECTORS BEAD LEVER

Position the bead lever between the demounting lip of the head and bead of tire. The demounting lip is on the right side of the head.

Push down on the tire sidewall 180 degrees from the mount/demount head to slip the bead into the drop center of rim.

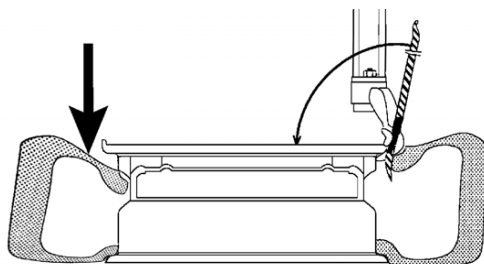

Using the bead lever tool, lift the tire bead over the demounting lip of the head.

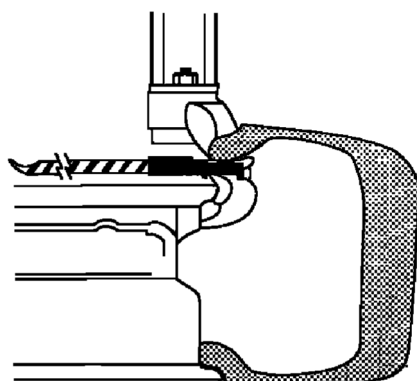

The bead lever tool must be pulled down parallel to the rim.



Press the wheel rotation pedal to rotate the wheel clockwise.

Remove the bead lever tool from the tire when it easily slides out, approximately after a quarter rotation of the wheel.



Continue to press the wheel rotation pedal to rotate the wheel clockwise until the entire bead is lifted from the rim.



Lift tire and repeat this procedure for lower bead.

Lift the mount/demount arm assembly up and away from the wheel.

Remove tire from rim.

*For additional information on demounting special wheels, refer to “Advanced Demounting Procedures,” page [32](#).*

## 2.4 Tire Inflation

	<p style="text-align: center;"> <b>DANGER</b></p> <ul style="list-style-type: none"><li>• <b>EXPLOSION HAZARD</b></li><li>• <b>Never exceed tire pressure recommended by tire manufacturer. Never mismatch tire size and rim size.</b></li><li>• <b>Avoid personal injury or death.</b></li></ul>
---	---

Verify that both upper and lower tire beads and rim bead seat have been properly lubricated with an approved mounting paste.

Do not lock the rim on the turntable during inflation

Remove valve stem core if not already done.

Connect inflation hose to valve stem.



Step down partially on the pedal to inflate tire and seal beads with inflation hose. Frequently stop to check bead seating pressure on gauge.

 <b>WARNING</b>
<p><b>Avoid personal injury. Follow the following instructions.</b></p>

1. Overinflated tires can explode, producing hazardous flying debris that may result in an accident.
2. Tires and Rims that are not the same diameter are “mismatched”. Never attempt to mount or inflate any tire and rim that are mismatched. For example, never mount a 16” tire on a 16,5” rim (or vice versa). This is very dangerous. A mismatched tire and rim could explode and result in an accident.
3. Never exceed the Bead setting pressure (gauge on hose) provided by the tire manufacturer stated on the sidewall of the tire.
4. Never place your head or any part of your body over a tire during inflation process or when attempting to seat beads. This machine is not intended to be a restraining device for exploding tires, tubes or rims.
5. Always stand back from the tire changer when inflating, never lean over.

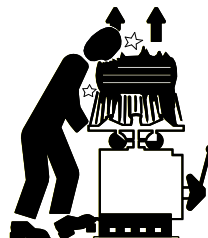



## WARNING

An exploding tire and rim may be propelled upward and outward with enough force to cause serious injury or death.

Do not mount any tire unless the tire size (molded into the sidewall) matches the rim size (stamped into the rim) exactly or if the rim or tire are defective or damaged.

This tire changer is not a safety device and will not restrain exploding tires and rims. Keep area clear of bystanders.

### Special procedure

In case during inflation the tire does not seat on the rim because of the excessive gap between tire/rim, it is possible to use an air-pressure airblast through jaws on turn table.

Verify that both upper and lower tire beads and rim bead seat have been properly lubricated with an approved mounting paste.

Remove valve stem core if not already done.

Connect inflation hose to valve stem.



Pull up on the tire lightly to reduce the gap between upper bead and the rim.



## WARNING

Do not stand over tire during inflation.

Step down completely on the air inflation pedal (pedal on the left side of the base) to release a high-pressure air blast through jets on the clamps to assist in seating the beads of the tire.

AIR-JET  
FROM HERE

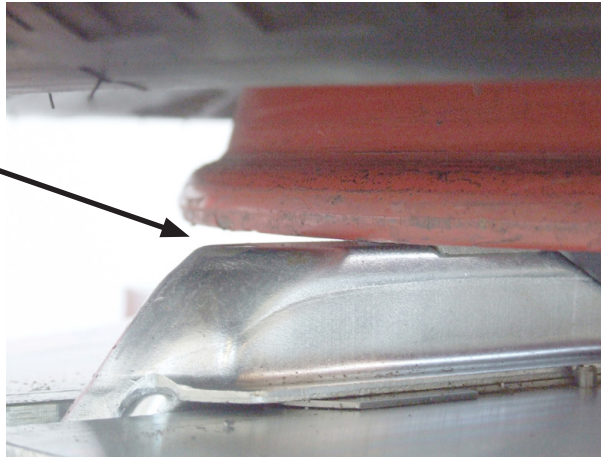

## NOTICE

To increase the effectiveness of the inflation jets, always liberally lubricate beads and raise the lower bead while activating inflation jets.

Step down partially on the pedal to inflate tire and seal beads with inflation hose. Frequently stop to check bead seating pressure on gauge.

## WARNING

Do not exceed tire manufacturer's maximum pressure as stated on the sidewall of the tire when seating beads.

Reinstall valve stem core into the valve stem after beads have been seated, and then inflate tire to vehicle manufacturer recommended pressure.

## WARNING

Activate air inflation jets only when sealing bead.

Bleed air pressure from system before disconnecting supply line or other pneumatic components. Air is stored in a reservoir for operation of inflation jets.

## WARNING

Only activate the air inflation jets if the rim securing device is locked in place and the tire is properly clamped.

## WARNING

Never mount a tire to a rim that is not the same diameter (e.g., 16 1/2 inch tire mounting on a 16 inch rim).

## WARNING

Never inflate using "shop air" on the tire changer.  
Use a safety cage in accordance with tire manufactures recommendations if inflation pressures beyond the tire changer equipped regulated air is required.

If tire is over-inflated, air may be removed from the tire by pressing the brass manual air release button located below the air pressure gauge.

Disconnect inflation hose from valve stem.

## 2.5 Removal of Wheel from Tire Changer

Lift the clamping pedal  to release the rim from the clamping device.

## 2.6 Optional Clamping Jaw Extensions

The clamping jaw extension / reducers add 4 inches (102 mm) of exterior clamping OR reduce external clamping by 5 inches (127 mm).

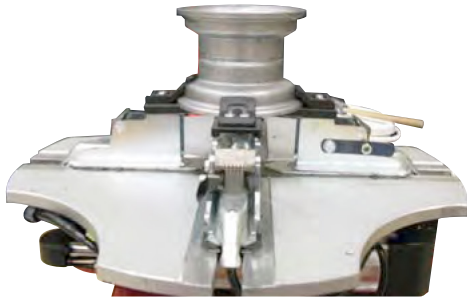

**JAW ADAPTORS IN REDUCER CONFIGURATION ON 6" WHEEL**



**JAW ADAPTORS IN EXTENSION CONFIGURATION ON 26" WHEEL**

The jaw adaptors may be configured for either extension or reduction by removing the two nuts and screws from the adaptor as shown below, rotating the adaptor plate 180°, and re-securing.

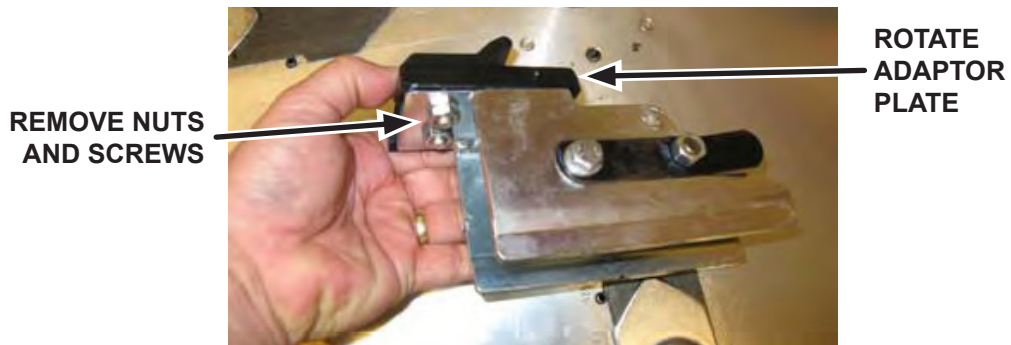

**JAW ADAPTORS IN REDUCER CONFIGURATION**



**JAW ADAPTORS IN EXTENSION CONFIGURATION**

# 3. Advanced Procedures

The capabilities of the TCX50H tire changer family allow the user to utilize numerous advanced procedures on a variety of rims and tires. For the operator to take advantage of these features, this section explains in detail what additional steps can be taken.

## 3.1 Advanced Bead Breaking Procedures

### Bead Breaking “AH” Wheels (e.g. BMW M3, M5, Some Porsches, Range Rover, Lancia, etc.)

“AH” (Asymmetrical Humps), “Bead Locking System” wheels may be identified by looking on the back of a rim for “AH” in the rim size designation casting (e.g. 8X17-AH).

“AH” wheels are designed so that the lowest point of the safety hump is located at the valve stem or 180 degrees out. These two points are where it is easiest to break the bead from the bead seat.

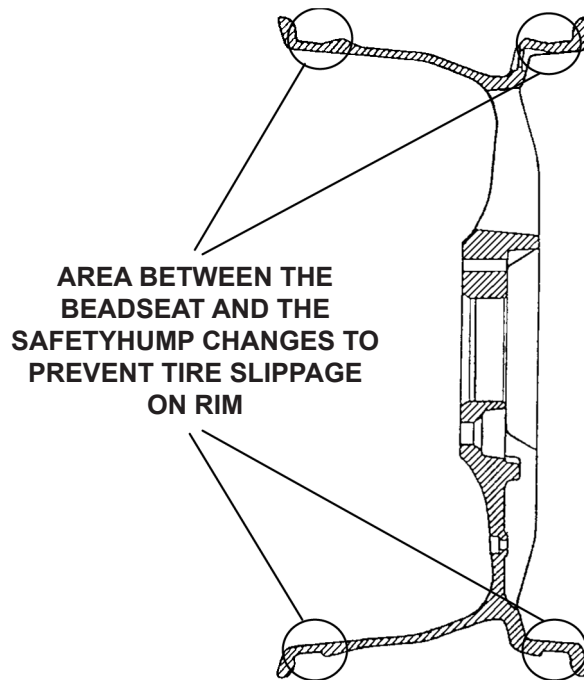

### Bead Breaking “AH” Wheels as follows:

Swing the bead breaker arm out and away from the housing.

Position the wheel against the side of the tire changer between the bead breaker arm and the housing.

Rotate the wheel so that the valve stem is in line with or 180 degrees from the blade.



Swing the bead breaker arm toward the tire and position the blade one to two inches from the edge of the rim on the sidewall of the tire.

Press the “in” button on the bead-breaker control handle.

The bead breaker arm will be pulled toward the tire changer to break the bead.

Press the “out” button to disengage the bead breaker arm.

If the bead has not been completely broken, rotate the wheel 180 degrees and repeat the bead breaking procedure.

Turn the wheel and break the opposite bead using the same procedure.

---

## 3.2 Advanced Demounting Procedures

### NOTICE

It is important on large, low profile tires to always lubricate the tire bead, wheel drop center, and bead seat to prevent possible tire damage during demount.

### Demounting Tire from Rim Using the Bead Lever Tool without the Plastic Sleeve Protector

Sometimes the sidewall of the tire is so stiff that use of the bead lever tool with the plastic sleeve protector is not possible. The technician needs every bit of clearance to be able to pry the bead of the tire up and over the mount/demount head.

#### Demounting Upper Bead

Position mount/demount head onto the outer edge of the upper rim lip.

Position bead breaker tool without plastic sleeve protector between demounting lip of the head and the bead of the tire. The demounting lip is on the right side of the head.

Using the bead lever tool, pry the tire bead over the demounting lip of the head.

Position the bead lever tool parallel to the rim.



Lift slightly on the wheel rotation pedal to rotate the wheel counterclockwise approximately 1/2 inch, to fully unfold the bead onto the mount/demount head.

Slide the bead lever tool out from between the mount/demount head and the tire.



Step down on the wheel rotation pedal to rotate wheel clockwise until the entire bead is lifted from the rim.

#### Demounting Lower Bead

Pull the tire up and tilt to place rear of lower bead in drop center behind mount/demount head.

Lubricate tire bead lever tool and then insert it over the demounting lip of the head and under the lower bead of the tire.

Pull the lower bead up and over the demounting lip of the head.

Push the bead lever half-way through tire and rim. Grasp inside of bead lever with one hand and grasp outside of bead lever at the base with the other hand. Firmly pull bead lever straight up.



Step down on the wheel rotation pedal to rotate wheel clockwise until the entire bead is lifted from the rim.



---

### 3.3 Advanced Mounting Procedures

Always use this “checklist” as a guide when mounting tires to ensure proper service.

There are four basic steps when mounting a tire to a rim:

- Position the bead on top of the rear lip of mount/demount head.
- Position the bead under the front lip of the mount/demount head.
- Lock the tire to the rim in the mounting position.
- Slip the bead into the drop center.

These four basic steps to mounting do not necessarily follow the same sequence, however all four steps need to be performed to properly mount a tire to a rim.

---

### 3.4 Mount/Demount Head Assembly

There are plastic and steel mount/demount head assemblies available for the TCX50H tire changer family. Both use standard procedures for mounting and demounting. To change the mount/demount head assembly:

- 1- Loosen the set screws (steel heads only) and the adjustment bolts.
- 2- Remove the head retaining bolt.
- 3- Remove the mount/demount head assembly.

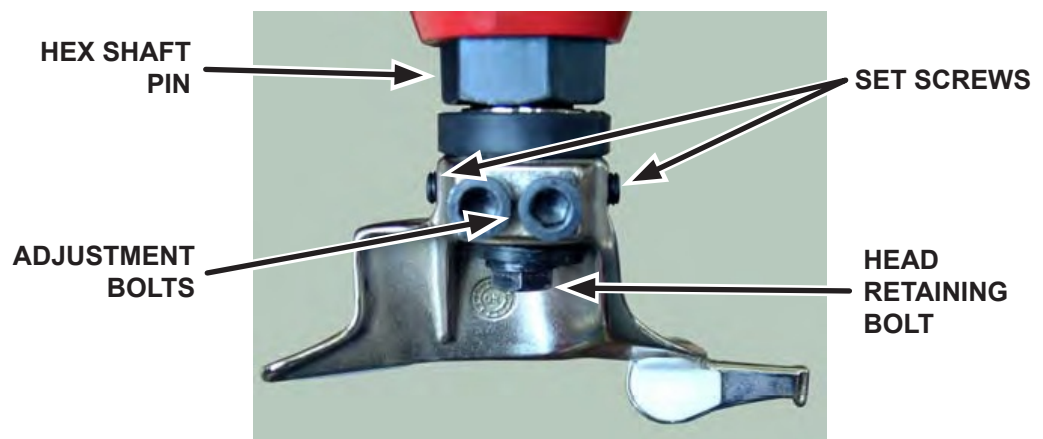

- 4- Place the mount/demount head assembly that you wish to use over the lower section of the hex shaft and reverse the above procedures to install.

#### Checking Mount/Demount Head Calibration For Steel Heads

Calibration will require the use of a 17-18 inch bare rim.

#### Set Position of Steel Mount/Demount Head on Hex Shaft

- 1- Clamp rim without a tire on the tire changer turntable.
- 2- Loosen the head retaining bolt slightly so that the head is still attached.
- 3- Loosen the two adjustment bolts and set screws so that the tool head can swivel on the hex shaft pin.

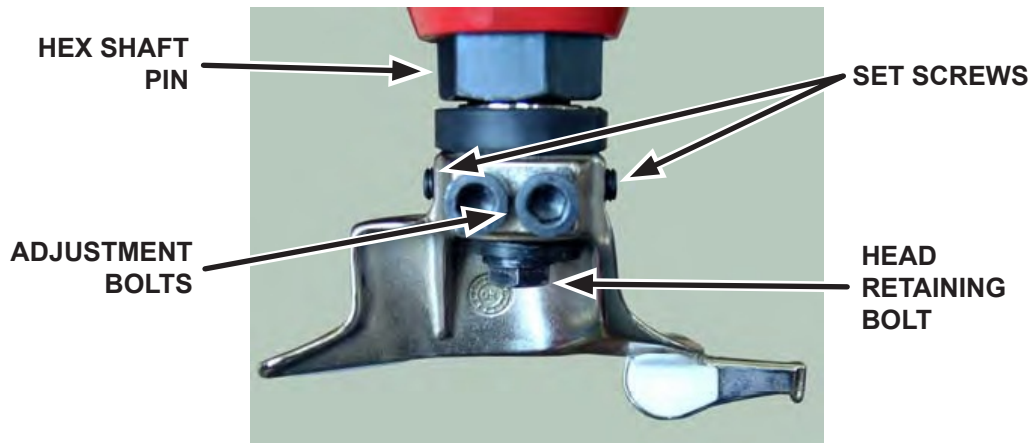

- 4- Position the tool head manually against the edge of the rim so that both sides of the tool head are resting on it.
- 5- Tighten the set screws in alternation to maintain 5/64 in. horizontal gap at leading and trailing edge of the mount head. Double check distance with feeler gauge. See above figure.
- 6- Keep the roller in contact with the edge of the rim, alternately loosen and tighten the two adjustment bolts until the gap is 1/4-inch.



**BACK EDGE OF HEAD**

**OVER-HANG**

**Measure with depth gauge**

**1/4-inch specification**

- 7- Fully tighten the set screws, checking when done that both sides of the tool head are still the same distance from the edge of the rim.
- 8- When the correct position has been achieved, tighten the adjustment bolts alternately to lock it in position.
- 9- Tighten the head retaining bolt.

Figure below is a summary of the desired end result.

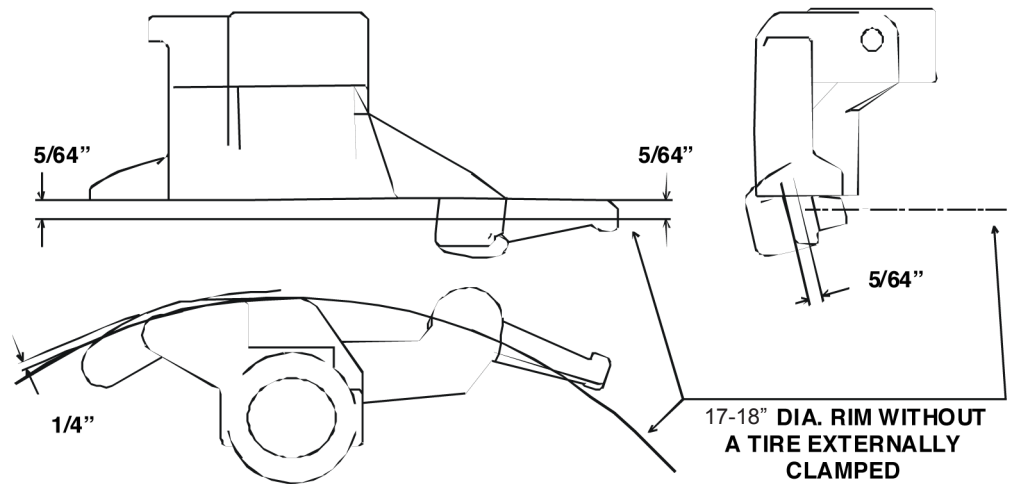

### For Tilting Plastic Heads

Figure below is a summary of the desired end result.  
The head will adjust itself to each rim diameter, due to its tilting feature.

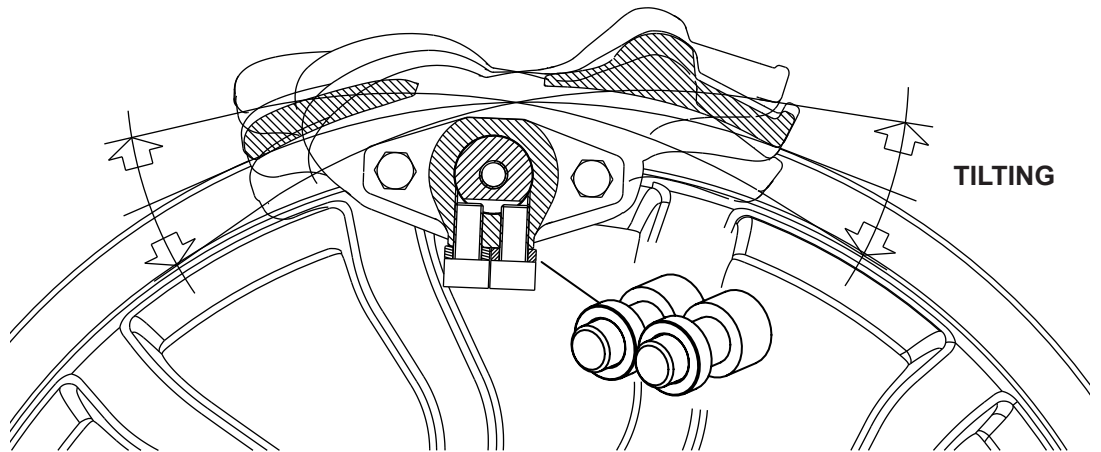

### Set Position of Plastic Mount/Demount Head on Hex Shaft

- 1- Fit the head on the hexagonal shaft.
- 2- Fully tighten the head retaining bolt being sure to insert the relevant washer and bushing.

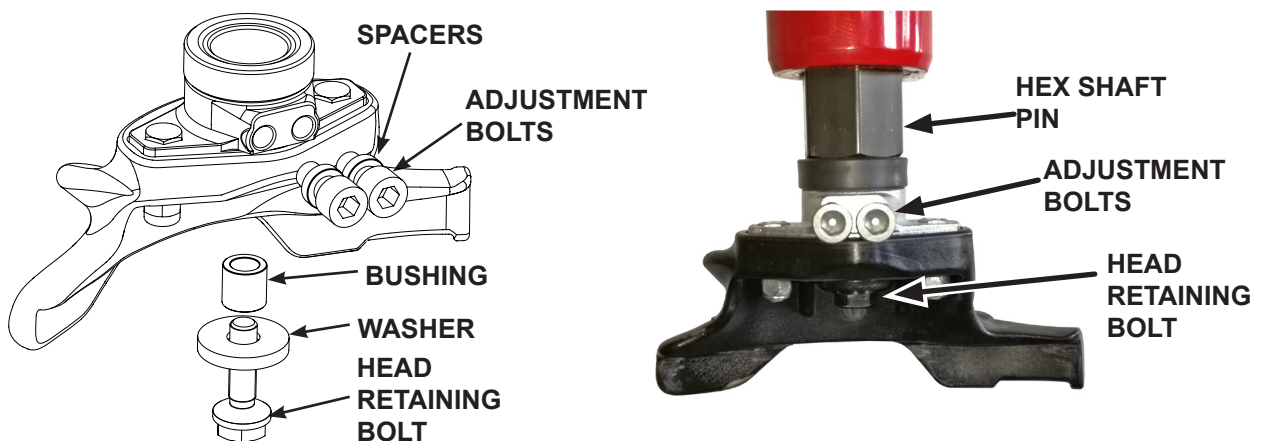

- 3- Fully tighten the adjustment bolts being sure to insert the two relevant spacers.

## Adjust the Offset of Lock Mechanism – Steel and Plastic Heads

- 1- Again, position the mount/demount head on the outer edge of upper rip lip and lock in this position.
- 2- Use gauges to measure distances between head and the top of the rim. Measure at inserts on steel head.



### TIRE MOUNTING LIP

#### TOP GAP

Measure with feeler gauge

**5/64-inch specification**



### TIRE DEMOUNTING LIP

#### SIDE GAP

Measure with feeler gauge

**5/64-inch specification**

Change the offset by removing the plastic cover and adjusting the nuts located on front of the locking mechanism.

Replace the plastic cover.

Confirm head clearances to the 17 in rim are correct. Position the mount/demount head on the outer edge and lock in this position. Check clearances.

# 4. TCX51H Operational Supplement

## BP Arm Operation

---

### 4.1 General Information

This chapter contains information for the correct use of the optional BP Bead Press Arm.

The BP Bead Press Arm has been designed as an accessory to help the operator mount the tire on the rim, or to demount the tire from the rim.

---

### 4.2 Part Identification

The functional parts of the BP Bead Press Arm are:



- |                           |                            |
|---------------------------|----------------------------|
| 1. Arm                    | 4. Air Cylinder            |
| 2. Bead Press Head w/hook | 5. Bead Press Roller (BPR) |
| 3. Control Switch         |                            |

## 4.3 Operation

The BP Bead Press Arm has been designed to facilitate the operations of wheel locking and mounting/demounting the tire on or from the rim. These operations, especially with low-profile, very wide tires, or very hard beads can be very difficult.

### Clamping the Wheel

Break the beads of the tire following the instructions in *Section 2.1, Bead Breaking, page 22*.

If you plan to clamp the wheel from the inside, follow the instructions in *Section 2.2, Clamping the Wheel from Inside of Rim - Steel Rims, page 23*.

If you plan to clamp the wheel from the outside, the BP can help with this operation. Follow these steps:

- 1- Release the turntable, bringing the tire changer operating arm and the BP Bead Press Arm to a non-working position.
- 2- Select the turntable opening so that the jaws touch the tire near the rim when putting the wheel on the turntable. Put the assembly onto the tire changer.
- 3- Set the pressure cone into the wheel center hole.



- 4- Center the arm over the wheel center hole. Using the adjustment clamp, lower the press head onto the pressure cone.
- 5- Using the control switch, lower the BP arm until the cone presses against the wheel, and forces it down approximately  $\frac{1}{4}$  –  $\frac{1}{2}$  inch.



- 6- Close the clamps on the wheel. Using the control switch, raise the BP arm until the cone is above the wheel far enough to be removed. Bring the arm back to its non-working position.

## Demounting

If the outer bead of the tire has “re-seated”, or needs additional lubrication, the bead loosening procedure can be repeated with the BP Bead Press Arm rather than the side shovel.

The BP Bead Press Arm can be used when removing the tire from the rim.

- 1- Position the mount/demount head on the tire and rim.
- 2- Insert bead lever.



### NOTICE

**The Bead Press Arm can also be used to create a gap for the bead lever.**

- 3- Position the Bead Press Arm head approximately 180° from the mount/demount head.
- 4- Lower the Bead Press Arm head so the bead is pressed downward toward the center of the rim.
- 5- Using the bead lever, pull the bead up and onto the mount/demount head.



- 6- Raise the Bead Press Arm up and out of the way.



- 7- Rotate clockwise to complete the demounting procedure.

## Using the Bead Press Head Hook to Lift the Tire

Use the hook on the bead press head to help lift the tire during demount. With upper bead demounted, use the bead lever and position the bead press head hook under the upper bead on the opposite side of the tire.



Raise the bead press head hook.



Use lever to hook lower bead and pull over rim. Remove the bead press head hook from the upper bead and complete removal of the lower bead.

## Mounting

Follow these steps:

- 1- Position the Bead Press Arm head near the mount/demount head. Lower it until the inner bead is level with the drop center.







- 2- Rotate clockwise . The Bead Press Arm head will revolve with the tire and keep the bead in the drop center. The second bead will thus be mounted on the rim without any effort or danger to the operator and without damaging the tire.
- 3- If equipped use the optional clamp to assist mounting when ever more difficult tires are being serviced.

A.

Use the clamp as traction point and use the press head to put the bead in the drop center of the rim.



B.

Use the press head as traction point and use the clamp to put the bead in the drop center of the rim.



# 5. TCX53H Operational Supplement Bead Press System Operation

---

## 5.1 General Information

This chapter contains information for the correct use of the optional Bead Press System (BPS).

The BPS has been designed as an accessory to help the operator mount the tire on the rim, or to demount the tire from the rim.

---

## 5.2 Part Identification

The functional parts of the Bead Press System are:

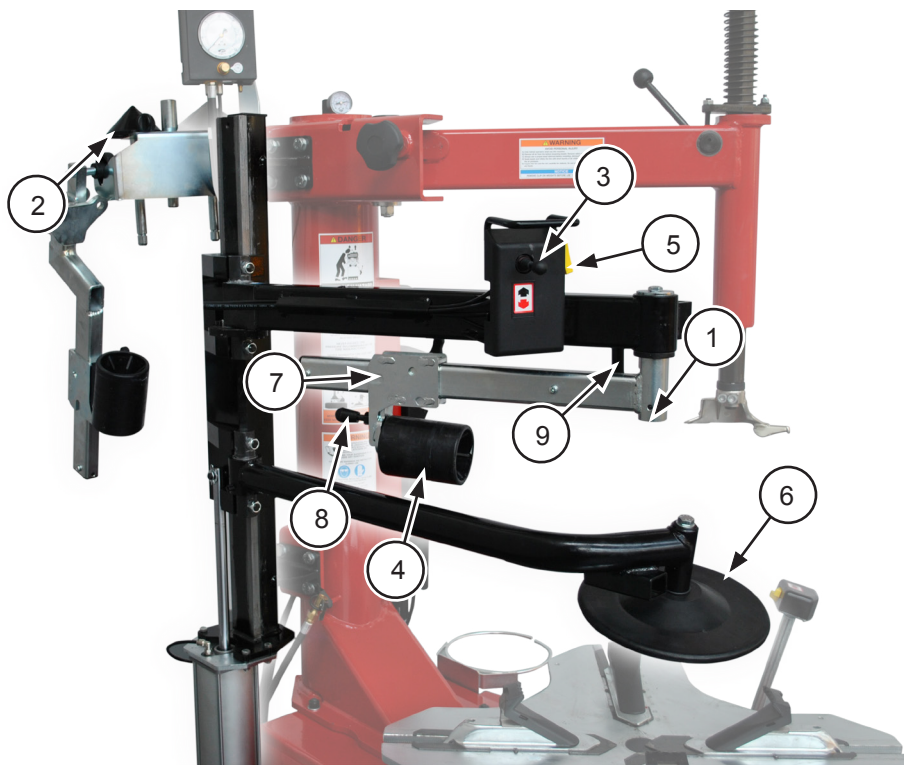

- |                        |                          |
|------------------------|--------------------------|
| 1. Articulated Arm     | 6. Tire Lifting Disc     |
| 2. Rim presser cone    | 7. Sliding locking lever |
| 3. Control Lever       | 8. Rotating locking pin  |
| 4. Bead presser roller | 9. Arm end of travel pin |
| 5. Arm releasing lever |                          |

---

## 5.3 Operation

The Bead Press System has been designed to facilitate the operations of wheel locking and mounting/demounting the tire on or from the rim. These operations, especially with low-profile, very wide tires, or very hard beads can be very difficult.

### Clamping the Wheel

Break the beads of the tire following the instructions in *Section 2.1, Bead Breaking, page 22*.

If you plan to clamp the wheel from the inside, follow the instructions in *Section 2.2, Clamping the Wheel from Inside of Rim - Steel Rims, page 23*.

If you plan to clamp the wheel from the outside, the Bead Press System can help with this operation. Follow these steps:

1. Release the turntable, bringing the tire changer operating arm and the Bead Press System to a non-working position.
2. Select the turntable opening so that the jaws touch the tire near the rim, when putting the wheel on the turntable.
3. Insert the rim pressure cone on the arm and push it upwards making sure the bayonet lock slips into place.
4. Set the arm in work position, it will automatically lock in line with the turntable.
5. Lower lever until the cone, as it presses against the wheel, forces it down a couple of centimeters. (The bead presser must be positioned so as not to touch the tire).



6. Close the clamps on the wheel. Raise the lever until the cone is above the wheel far enough to be removed. Remove the bead pressing cone and bring the arm back to its non-working position.

### Lubrication of Outer Bead

If the outer bead of the tire has “re-seated”, the bead loosening procedure can be repeated with the Bead Press System rather than the side shovel. Follow these steps:

1. Pull the roller locking knob towards the outside so that the roller is free to turn on its axis. (For all other operations done with the Bead Press System, this knob must be inserted to prevent the roller from turning).
2. Bring the arm to its work position. Press the lever so that the roller can slide on the arm and position near the edge of the rim. Release the lever.

3. Move the control lever downwards until the roller presses on the tire and the bead moves a few millimeters away from the rim, then rotate the turntable clockwise. The swivel arm will turn with the tire until it comes against the end travel stop. At this point the roller will begin to loosen the top bead on the tire. (When the top bead has been pushed into the drop center, the operator can lubricate the bead and the rim thoroughly to facilitate the subsequent demounting stages).



4. When the operation has been completed, lift off the roller, move the Bead Press System away from the turntable, and begin the demounting operations.

### Demounting the Outer Bead

1. Move the toolhead to the work position. If the wheel has a sensor, turn the table top until this sensor is lined up with the toolhead.
2. Move the arm of the BPS to the work position.
3. Move the bead presser roller out to the tire and to the right of the toolhead.
4. Operate the BPS control lever in order to press on the tire and create sufficient space to correctly position the toolhead and subsequently insert the bead lifting lever.



5. Lock the toolhead in place and insert the bead lifting lever.
6. Operate the BPS control lever and lift the arm, then turn it and move the bead presser roller opposite the toolhead.

7. Operate the BPS control lever to lower the arm and put pressure on the tire until the bead is in the drop center of the rim. This prevents the bead from being excessively taut and allows it to rise more easily on the toolhead.



8. Lift the arm of the BPS and swing it outwards to free the work surface, then turn the table top to allow the outer bead to slip out.

## NOTICE

**If the sidewall is so rigid that the bead is unable to position in the drop center, the operation can be facilitated by using the second BPS roller. Mount the second roller on the BPS, positioning it to the left of the BPS roller, halfway between the BPS roller and the toolhead.**

### Breaking the Inner Bead

If the inner bead has re-seated, use the tire lifting disc to loosen it. Follow these steps:

1. Mount the tire lifting disc on to the lower arm holder and lock it in place with the pin.
2. Position the tire lifting disc under the tire, making sure that it is near the edge of the rim.
3. Position the bead lever in the hole on the tire lifting disc arm and hold it to keep the tire lifting disc pressed against the tire.



4. Rotate the turntable clockwise simultaneously raising the tire lifting disc up, with the control lever until the bead-loosening procedure is completed. (Thoroughly lubricate the inner bead before removing it).

## Demounting the Inner Bead

1. If the wheel has a sensor, rotate the table top until it lines up with the toolhead.
2. Position the tire lifting disc under the inner bead, then, using the BPS control lever, lift the bead until it is in the middle of the drop center. Take care not to damage the sensor when doing this.



3. Insert the bead lifting lever on the toolhead until it has picked up the inner bead. Raise the bead lifting lever until the inner bead rises on to the toolhead.
4. Turn the table top clockwise until the tire has been completely removed.

## Operations and Inspections Prior to Mounting

1. Check the tire and rim for any defects.
2. If the wheel has an internal sensor, make sure that it is not defective and/or damaged. If damage is discovered, replace the sensor (refer to vehicle's maintenance manual).

## Mounting the Inner Bead

1. Clamp the rim on to the table top from the outside only.
2. Move the tool arm to the work position and clamp the toolhead on to the rim.
3. Thoroughly lubricate the rim and tire beads.
4. If the wheel has an internal sensor, position it on the right hand side of the toolhead.
5. Position the tire so that the inner bead (lower one) is under the toolhead.
6. Turn the table top clockwise. Keep the tire pressed against the rim so that the inner bead "slips" into the drop center.

## Mounting

Follow these steps:

1. Clamp the rim on the tabletop and mount the outer bead as described in Chapter 2, Basic Procedures, page 22.
2. Position the roller near the mount/demount head. Lower it until the inner bead is level with the center well. If the tire bead fails to "rise" on the mount/demount head, using the bead lever can facilitate the operation.
3. As the turntable turns the roller will revolve with the tire and keep the bead in the well. The second bead will thus be mounted on the rim without any effort or danger to the operator and without damaging the tire.

## Special Procedure for Run Flat Wheels / Low Profile

With the second roller arm, the Bead Press System can correctly work on Run Flat wheels.

### NOTICE

The majority of Run Flat wheels are equipped with an internal sensor so that the pressure can be measured. Before proceeding with any operation on the wheel, check the vehicle instruction manual for the type of sensor used and its position on the rim.

### NOTICE

Before proceeding with any operation on the wheel, make sure that all contact points between the tire changer and rim (mounting/demount head, bead lifting lever, tire lifting disc, wheel clamps) are equipped with their relative plastic guards.

## Bead Breaking

If the wheel does not have an internal sensor, the bead can be loosened in the “conventional” way as described in *Section 2.1, Bead Breaking, page 22*.

If it does have an internal sensor, the procedure will depend on the type and position of the actual sensor itself, i.e. “conventional” bead breaking on both beads or on the inner bead alone. In all cases, proceed with the utmost care. Never press the shovel near the pressure sensor.

## Second Roller Attachment

The second roller attachment must only be mounted on the Bead Press System at the time it is actually used and taken off the Bead Press System at the end of the operation. This prevents it from hampering the other operating phases or from being a potential source of danger through crushing.

1. Insert the second roller attachment into its housing on the arm of the Bead Press System.
2. Lock in place with the pin.

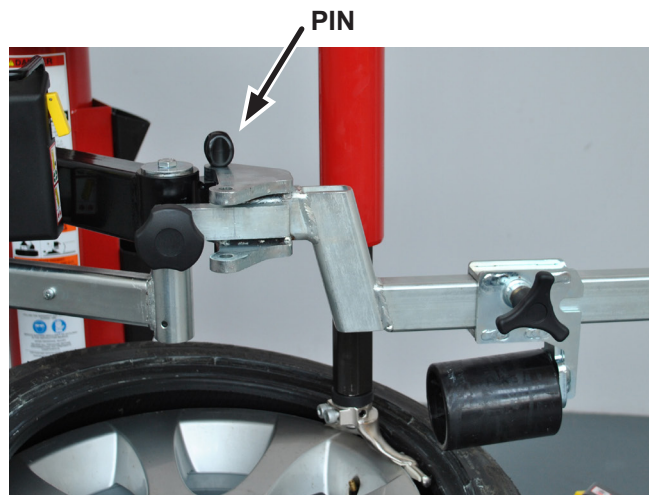

## Mounting the Outer Bead

1. If the wheel has an internal sensor, position it directly across from the toolhead.
2. Mount the second roller arm on the BPS.
3. Position both rollers as shown below.



4. Lower the arms until the outer bead is in the drop center and under the hooked section of the toolhead.
5. Turn the table top clockwise, the BPS roller will turn along with the tire, allowing the outer bead to slip into the rim, while the second roller will remain at a standstill in its position, preventing the bead from slipping out again.





## Sensor Inspection/Replacement

If the wheel has an internal sensor, the BPS used with the second roller will allow you to inspect and replace the actual sensor itself without having to remove the tire from the rim.

### **NOTICE**

**Only work on the sensor after having consulted the operation and maintenance manuals of the vehicle and sensor itself.**

Proceed in the following way:

1. Break the bead as described in Section 2.1, Bead Breaking, page 22.
2. Clamp the rim on the table top and position the sensor at 5:00 o'clock (use vertical post as reference - 12:00 o'clock).
3. Move the arm of the BPS to the work position with the roller at 7:00 o'clock.
4. Mount the BPS second roller and position it at 4:00 o'clock.
5. Using the BPS control lever, slowly lower the rollers until you have enough space to check or replace the sensor. Take the utmost care to prevent the bead from touching the sensor during this operation.









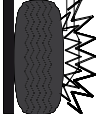

6. After having terminated the operations, slowly lift the rollers until the bead has passed over the sensors.

# 6. Maintenance

## 6.1 Maintenance Schedule

	 <b>DANGER</b>
	<ul style="list-style-type: none"> <li>• <b>EXPLOSION HAZARD</b></li> <li>• Never exceed tire pressure recommended by tire manufacturer. Never mismatch tire size and rim size.</li> <li>• Avoid personal injury or death.</li> </ul>

 <b>NORMAL RIMS UP TO 10"</b>		<b>▲ WARNING</b> <b>CRUSH HAZARD</b>		<b>▲ WARNING</b> <b>CRUSH HAZARD</b>		<b>▲ WARNING</b> <b>EXPLOSION HAZARD</b>
 <b>WIDE RIMS OVER 10"</b>		<b>KEEP HANDS CLEAR OF ROTATING TABLE</b>		<b>KEEP ARMS AND LEGS CLEAR OF BEAD BREAKER</b>		<b>DO NOT BREAK BEAD WITH AIR PRESSURE IN TIRE.</b>
  <p><b>CRUSH HAZARD.</b></p> <p>Before making any adjustments or carrying out maintenance, disconnect the electrical and compressed air supplies from the equipment and make sure that all moving parts are suitably immobilized.</p>						

	 <b>DANGER</b>
	<ul style="list-style-type: none"> <li>• <b>HAZARDOUS VOLTAGE</b></li> <li>• Turn off and lock out system power before servicing.</li> <li>• Contact may cause electric shock or death.</li> </ul>

Before carrying out cleaning or maintenance operations on the machine or when replacing machine parts, disconnect. Follow any "lock out – tag out" procedures in your jurisdiction. See your supervisor for additional information. Should any maintenance task require the disabling, removal or disassembling of any safety device, that device must be immediately restored or replaced when the maintenance is complete.

Wear personal protective equipment (PPE) and clothes, in compliance with the local rules and regulations, including but not limited to OSHA. See your supervisor for instructions. If you have any questions concerning the proper use or maintenance of your machine, please contact your nearest Hunter Engineering Company representative. You can also contact Hunter Engineering Company at **Tel: 800-448-6848 or 314-731-3020.**

In case of a written request, please specify the:

- Machine model.
- Serial number.
- Detail of the problems encountered.
- Inspections that have been performed.
- Adjustments made and their outcome.
- Any other useful information.

You may address your written requests to:

**HUNTER ENGINEERING COMPANY**

11250 Hunter Drive  
Bridgeton, Missouri 63044

Fax: 314-731-1776

e-mail: [Customerservice@hunter.com](mailto:Customerservice@hunter.com)

The components of Hunter Engineering Company products are designed as a single integrated system. To avoid compromises in terms of safety, performance, durability and function, and to prevent voiding of the warranty, do not substitute Hunter Engineering Company components with components manufactured by other companies. Use only ORIGINAL replacement PARTS supplied by Hunter Engineering Company.

During maintenance procedures,

- Never modify or alter the machine or any of its components.
- Use proper stairs, ladders or platforms to access areas that cannot be reached from ground level.
- Use appropriate personal protection equipment (PPE), such as eye protection, face shield, respiratory protection, gloves and coveralls, when performing maintenance, repairs or adjustments in compliance with local and OSHA regulations. Check with your supervisor.
- Never attempt any repairs or adjustments to any hydraulic component or auxiliary unit, including pumps, hoses, fittings, if the system is pressurized or operational or if the machine is in operation. Always shut down the machine, relieve all pressure and wait for all motion to come to a complete stop before performing any repairs or adjustments.

Maintenance Schedule	Perform the Following Maintenance
<b>Daily</b>	<p>Drain condensation from pressure regulator reservoir by pressing in on the fitting located on the bottom of the regulator.</p> <p>Check for worn or damaged rubber and nylon components that should be replaced to prevent damage from occurring. Replace worn parts as needed (tool supports, rubber pads, lever protector sleeve and mount/demount head).</p> <p>Clean all areas that contact rims or tires to prevent possible scratching to rim.</p>
<b>Weekly</b>	<p>Clean tire changer with shop towels or a vacuum cleaner. <b>Do not clean with or use compressed air, which can blast dirt between moving parts.</b></p> <p>Do not use cleaning solvents to clean pressure regulator/oiler.</p>
<b>Periodically</b>	<p>Refill the pressure regulator/oiler using only Hunter Lubri-Oil, 148-133-2, as needed. <b>Petroleum-based oils should never be used in the oiler and may void all warranties.</b></p> <p>Adjust the oiler to release one drop of oil every three rotations of the clamping table by adjusting the screw on top.</p> <p>Check for loose bolts and tighten per specifications.</p>

## 6.2 Maintenance and Replacement Parts

NAME	NUMBER
Safety Goggles	179-15-2
Brush	RP6-1506
Mounting Paste	RP6-3784
Polymer Mount/Demount Head	RP11-3314813
Hand Held Bead Lever - straight	RP11-3009516
Bead Lever Protector Sleeve (HM)	RP6-0326
Bead Lever Protector Sleeve (Std) (4)	RP11-8-11400098
High Grip Jaw Protection Kit (2 sets - 8 covers)	RP11-8-11100358
Steel Head Inserts (10 sets - 20 covers)	RP11-8-11400096
Clamping Jaw Extensions AR46 (4)	RP11-8-11400276

# 7. Glossary

## 7.1 Rim Diagram

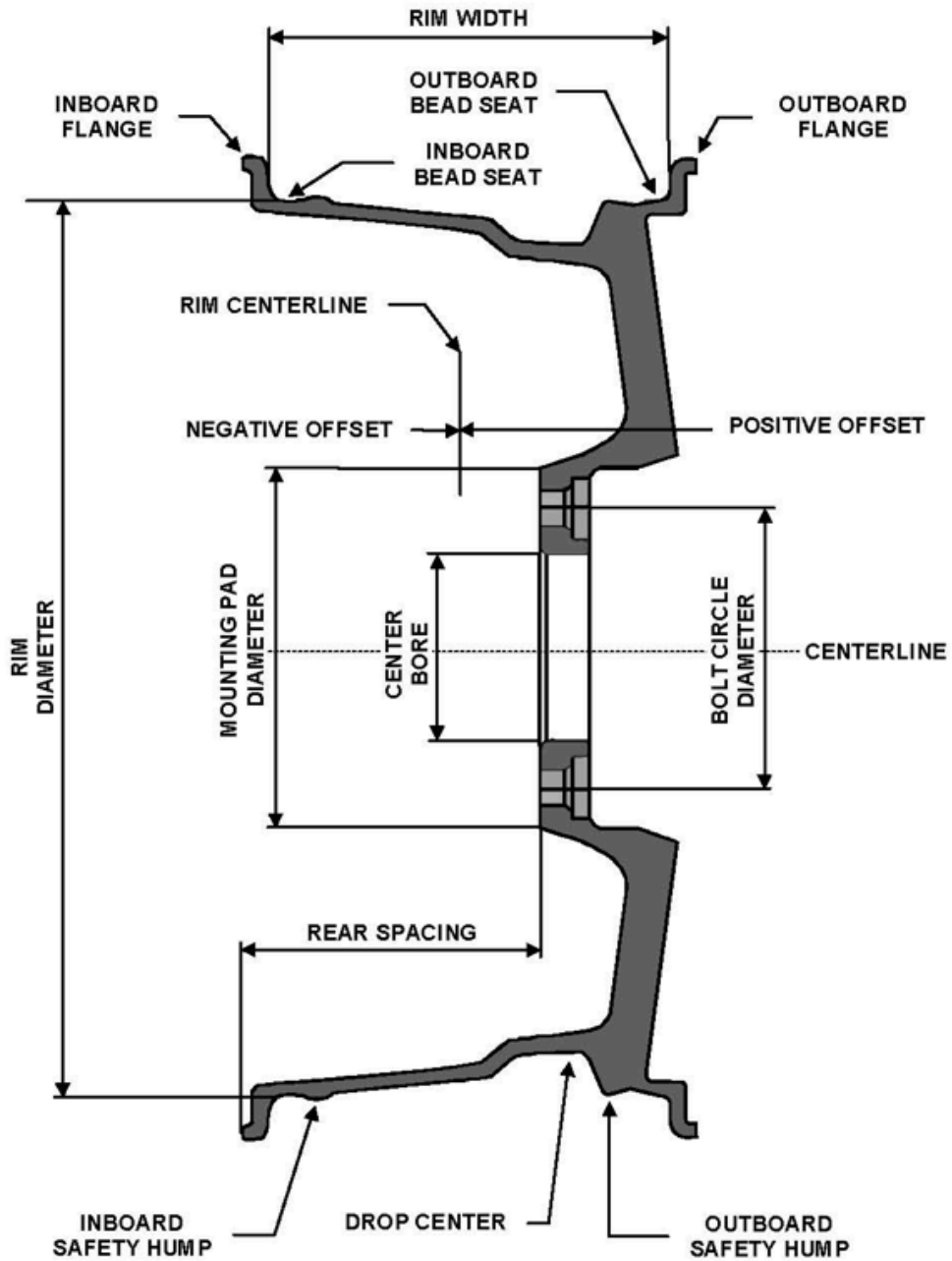

## 7.2 Illustrations of Various Rim Designs

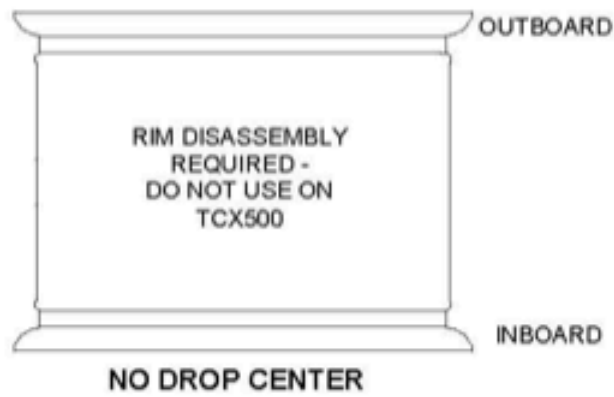
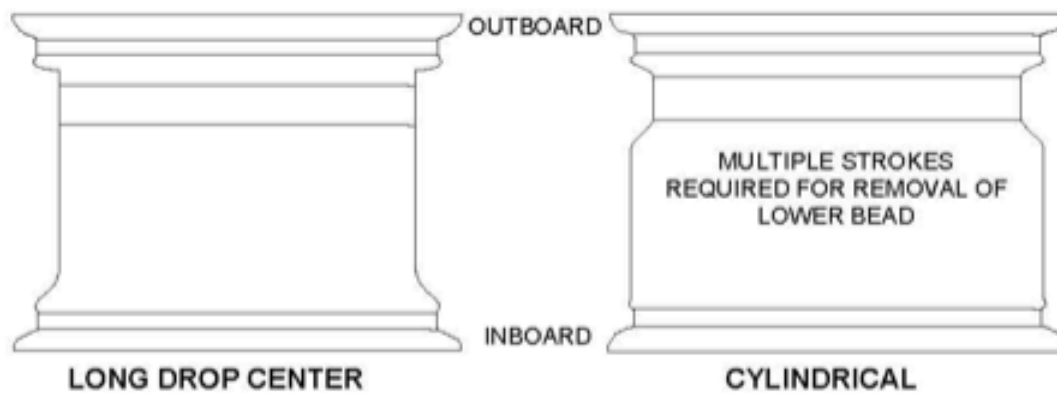
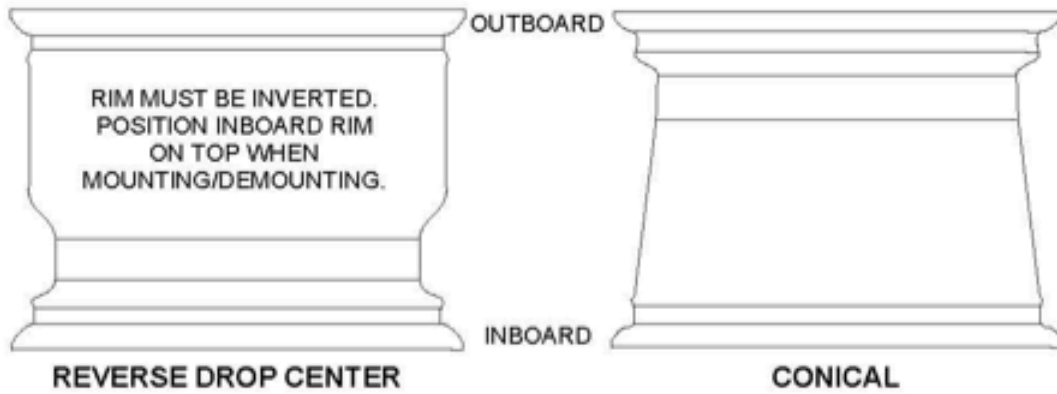

# Hunter Research and Training Center



## HUNTER TRAINING

Hunter operates the most advanced, up-to-date Training Center in the industry today.

The courses have been designed to meet the needs of new and experienced technicians who want to increase their mechanical and diagnostic capabilities. The low student-teacher ratio (average 7 to 1) and the emphasis on “hands-on” training (70% time in shop) create an excellent learning environment.

Highlights of the Hunter Training Center include:

- ✓ An instruction staff with years of shop, field, and teaching experience.
- ✓ Fully-equipped service bays.
- ✓ Classrooms equipped with modern teaching aids.
- ✓ The most up-to-date wheel alignment, balancing service, and brake equipment on the market today.

## Classes Available

- Align 1 (Basic Alignment Theory and Practice) - 3 day / 24 hours
- Align 2 (Advanced theory / Aftermarket Adjustment) - 2 day / 16 hours
- Align 3 (Advanced Diagnostics and OEM Procedures) - 2 day / 16 hours
- Performance Tire (Basic and Advanced Tire Changing) - 1 day 8 hours
- Road Force® / GSP9700 Certification - 2 day / 16 hours
- Rolling Smooth (Basic & Advanced vibration theory) - 1 day / 8 hours
- Heavy-Duty Truck Alignment 1 (Fundamental Alignment) - 3 day / 24 hours
- Heavy-Duty Truck Alignment 2 (Advanced Alignment) - 2 day / 16 hours



cod. 4-122607 - 07/17

**HUNTER**  
Engineering Company

[www.Hunter.com](http://www.Hunter.com)